



CLARIVEIN® IC, INFUSION CATHETER



WARNING

Contents supplied STERILE using an ethylene oxide (EO) process. Do not use if sterile barrier is damaged. If damage is found, call your company representative. Inspect prior to use to verify that no damage has occurred during shipping.

For single patient use only. Do not reuse, reprocess or resterilize. Reuse, reprocessing or resterilization may compromise the structural integrity of the device and/or lead to device failure, which, in turn, may result in patient injury, illness or death. Reuse, reprocessing or resterilization may also create a risk of contamination of the device and/or cause patient infection or cross-infection, including, but not limited to, the transmission of infectious disease(s) from one patient to another. Contamination of the device may lead to injury, illness or death of the patient.

After use, dispose of product and packaging in accordance with hospital, administrative and/or local government policy.

DEVICE DESCRIPTION

The ClariVein® IC is a specialty infusion catheter with 360° Rotatable Dispersion Wire connected to a proximally located integral battery powered Motor Drive Unit (MDU). The MDU includes the Speed Selector, handle grip and Syringe Locking Support features to facilitate physician-controlled infusion of the selected agent. The ClariVein® IC is introduced through a microintroducer. Utilizing vascular imaging, the coaxial Catheter Sheath with Dispersion Wire is navigated through the vasculature to the treatment site. Fluid delivered through the Catheter Assembly's Check Valve and Injection Port surrounds the Dispersion Wire and exits via an opening at the distal end of the catheter. The ClariVein® IC has no user serviceable parts or capital equipment. It is fully disposable.

CONTENTS

- 1 ClariVein® IC
- 1 Syringe 5 mL

INDICATIONS FOR USE

The ClariVein® IC is indicated for infusion of physician-specified agents in the peripheral vasculature.

INTENDED USE

The ClariVein® IC is intended for the infusion of physician-specified agents in the peripheral vasculature.

CONTRAINDICATIONS

The ClariVein® IC is not intended for use in the following:

- Coronary and cerebral vasculature
- Pulmonary vasculature
- Diseased and atherosclerotic arteries
- Infusion of blood and blood products

WARNINGS

- This product should be used by physicians that have a thorough understanding of intravascular ultrasound, angiography, peripheral vascular procedures and anatomy.
- Prior to use, carefully examine the ClariVein® IC and package contents included with ClariVein® IC and verify they have not been damaged during shipment. If the components show any sign of damage DO NOT USE.
- After use, dispose of the product per institutional protocol.
- Due to the risk of exposure to HIV or other blood borne pathogens, health care workers should always use standard blood and body fluid precautions in the care of all patients. Sterile techniques should be strictly adhered to during any handling of the device.
- Do not modify the device. To do so could result in injury, illness, or death.

CAUTIONS

- Do not use the ClariVein® IC in patients contraindicated for endovascular procedures.
- Do not use without completely reading and understanding the instructions for use.
NOTE: Packaging contents contains no medications. Prior to use, carefully read and understand the respective manufacturer's instructions for procedural accessory devices and solutions intended for use including warnings, cautions, potential side effects and contraindications.
- Before using ClariVein® IC, verify proper function and integrity of the device.
- Refer to package label for expiry date and do not use after expiration.
- Rotation of the ClariVein® IC Dispersion Wire is internally powered via a 9V DC battery. Prior to use of the device, remove the Battery Terminal Insulator Tab by pulling tab away from device.
- The integral 9V, DC battery is not intended to be either removed or replaced.
- Do not use in the presence of a flammable anesthetic mixture with air or with oxygen or nitrous oxide in order to reduce any potential of static discharge or other ignition hazards.
- Select an appropriately sized vascular access device.
- Failure to use a compatible access device may result in damage to the device or cause patient injury.
- Confirm syringe and Check Valve connections. Do not use if a leak persists.
- Manipulate the catheter in the vessel only under vascular imaging.
- Do not exert excessive force when withdrawing or advancing catheter. If resistance is encountered, determine if remedial action is necessary. Failure to do so may result in device damage or patient injury.
- Utilize vascular imaging such as ultrasound to confirm that the catheter tip is in the desired location before activation of Dispersion Wire rotation.

- When mating the MDU onto the Catheter Assembly Cartridge, do not bend or kink the Dispersion Wire. To do so could cause damage to the device or patient injury.
- Slowly withdraw the device through the treatment area after Dispersion Wire activation. A draw rate of approximately 1-2 mm/second is recommended while simultaneously infusing fluid.
- Potential fatigue failure of the ClariVein® IC Dispersion Wire may occur with prolonged activation of the device, which could result in device breakage.
- Prior to the Dispersion Wire rotation activation, confirm that the Catheter Assembly Cartridge is securely mated in Position 2 in the MDU to avoid damage to the device and/or patient injury.
- Do not advance the Catheter Assembly when the Catheter Assembly Cartridge is mated to the MDU and is in Position 2.
- Upon completion of the infusion procedure, prior to removal of the ClariVein® IC, move the Catheter Assembly Cartridge to Position 1 in the MDU to avoid damage to the device and/or patient injury.
- The Catheter Assembly and Motor Drive Unit cannot be separated after the Catheter Assembly is moved to Position 2.

ADVERSE EVENTS

Potential adverse events that might be encountered during a peripheral vasculature infusion procedure using the ClariVein® IC are similar to those associated with any interventional procedure and include, but are not limited to, the following:

- | | |
|--|-----------------------------------|
| 1. Abrupt thrombosis and occlusion of the treated vessel | 8. Embolization |
| 2. Bleeding from the site of access | 9. Reaction to infused substances |
| 3. Vascular rupture and perforation | 10. Pain |
| 4. Vascular dissection | 11. Pseudoaneurysm |
| 5. Hemolysis | 12. Hypotension, Hypertension |
| 6. Hematoma | 13. Infection at the access site |
| 7. Neurological deficits including stroke | 14. Death |

HOW SUPPLIED

Contents supplied STERILE using an ethylene oxide (EO) process. Do not use if sterile barrier is damaged. If damage is found, call your Vascular Insights™ representative. Do not use if labeling is incomplete or illegible.

Handling and Storage

Store in cool, dry place.

DISPOSAL INSTRUCTIONS

After use, dispose of the products used in the procedure per institutional protocol.

Please note that the ClariVein® MDU unit contains a 9V DC battery, which is **not** intended for removal. As such, the entire product, including the MDU is considered an infected medical device and is fully disposable as medical/biohazard waste and is **not** intended to be included in used electronic equipment recycling programs.

OPERATIONAL INSTRUCTIONS

Procedural Accessory Devices and Agents

Prior to use, carefully read and understand the respective manufacturer's instructions for procedural accessory devices and solutions intended for use including warnings, cautions, potential side effects and contraindications.

Patient Preparation

1. Use sterile technique per institutional protocol.
2. Medicate patient as appropriate.
3. Prepare and drape the puncture site.
4. Select an appropriately sized access device to accommodate the ClariVein® IC.
Recommended access device should be equal to or greater than a 4F introducer or 18G Short Peripheral Catheter.
5. Administer local anesthetic at puncture site as needed per institutional protocol.
6. Prepare and place the access device per manufacturer's instructions.

Device Preparation

1. Inspect the product package prior to opening. **Do not use** if package is opened or damaged.
2. Use sterile technique to carefully remove the tray from the pouch and the contents from the tray.
3. Inspect the device to be certain there are no visible signs of damage. **Do not use** if contents are damaged.
4. Remove Battery Terminal Insulator Tab from the MDU and discard. (Figure 2, Item 12)
5. Confirm that the MDU has power by engaging the trigger (Figure 2, Item 10) and confirming the Green Indicator Light is illuminated. (Figure 2, Item 13)

NOTE: The Dispersion Wire will not rotate if Green Indicator Light does not illuminate.

6. To attach the Check Valve turn clockwise onto the Catheter Assembly injection port. (Figure 1, Item 2; Figure 3, Item 14)
7. Flush normal saline (USP 0.9%) through the Check Valve and Catheter Injection Port to confirm a secure connection and patent catheter. (Figure 1, Item 2)

Caution: If leak is detected, reconfirm syringe and Check Valve connections. Do not use if a leak persists.

8. Fill the 5 mL syringe with agent to be infused. (Figure 3, Item 15)

Figure 1: Catheter Assembly

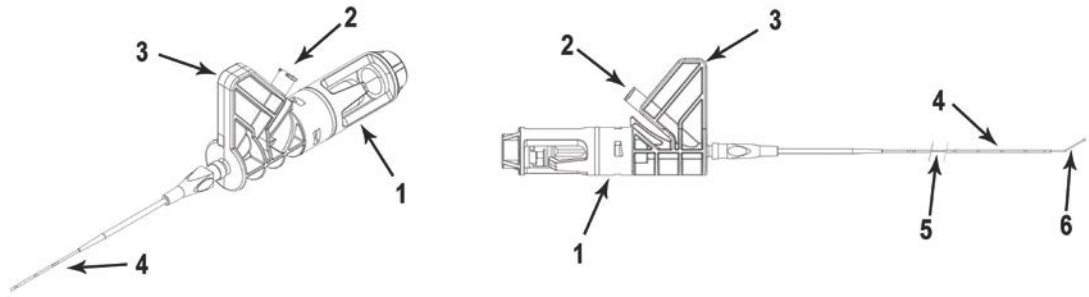

- | | |
|-------------------|------------------------------|
| 1. Cartridge | 4. Catheter Sheath |
| 2. Injection Port | 5. Rotatable Dispersion Wire |
| 3. Guide Wing | 6. Dispersion Wire Tip |

Figure 2: Motor Drive Unit

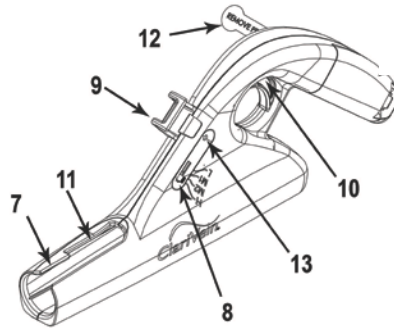

- | | |
|---|--|
| 7. Mating Alignment Channel Position 1 | 11. Mating Alignment Channel Position 2 |
| 8. Speed Selector | 12. Battery Terminal Insulator Tab |
| 9. Syringe Locking Support | 13. Green Indicator Light |
| 10. Trigger | |

Figure 3: Catheter Assembly with Check Valve and Syringe

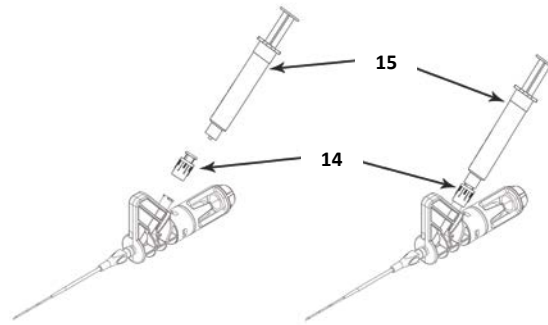

- 14. Check Valve
- 15. Syringe 5 mL

Catheter Assembly Positioning

1. Utilize vascular imaging guidance (e.g. ultrasound) to thread the ClariVein's coaxial Catheter Sheath and Dispersion Wire through the access device to the desired position within the peripheral vasculature.

Joining Catheter Assembly to the Motor Drive Unit (MDU):

1. Maintain position of the catheter and dispersion tip within the peripheral vessel.
2. Hold the Guide Wing and advance the MDU onto the Catheter Assembly's Cartridge for initial mating in the alignment channel Position 1 (Figure 2, Item 7; Figure 4). Exercise care **not** to bend or kink the proximal end of the catheter.

NOTE: Once placed into Position 2, the Catheter Assembly is **not removable** from the MDU.

3. Using vascular imaging guidance confirm that the Dispersion Wire Tip remains in desired position. Adjust as needed.
4. Place the Cartridge in the final position on the MDU by simultaneously advancing the MDU while applying slight pressure on the Syringe Locking Support. The cartridge will snap into alignment Position 2.

NOTE: The electrical circuit is now armed and the Dispersion Wire Tip is now **unsheathed**.

5. Snap the syringe into the MDU Syringe Locking Support and ensure it is fully engaged. (Figure 2, item 9)
6. Utilizing vascular imaging guidance, reconfirm that the Dispersion Wire Tip remains in desired position within the vessel. Adjust as needed.

Figure 4: Connected Catheter Assembly with MDU

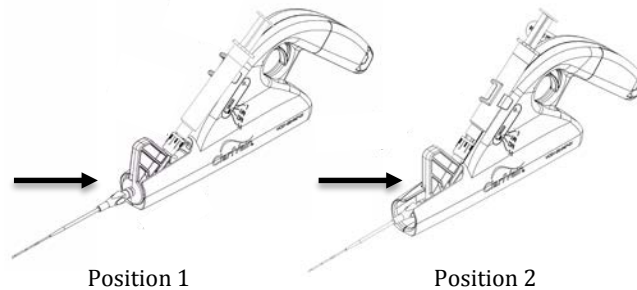

Rotatable Dispersion Wire Activation:

1. Select the rotation speed using the speed selector on the MDU. (Figure 2, Item 8)

The four speed positions are labeled as L, M1, M2, and H, and represent approximately the following:

- a. L – low, 2,000 RPM
- b. M1 – medium, 2,500 RPM
- c. M2 – medium high, 3,000 RPM
- d. H – high, 3,500 RPM

2. Activate rotation of the Dispersion Wire by depressing the Trigger. (Figure 2, Item 10)

Catheter Sheath Marking Guide

Black: A single ‘hash’ mark denotes 1 cm increment; and a double ‘hash’ mark denotes 10 cm increment.

White: A single ‘hash’ mark denotes approximately 8 cm from the Dispersion Wire Tip when the Dispersion Wire is unsheathed.

Procedural Steps

1. Slowly withdraw the device through the treatment area while simultaneously infusing the physician-specified agent.
 - Recommended technique:
 - Depress the syringe plunger with the thumb of the same hand that is holding the MDU. (Figure 4).
 - A pull back rate of 1-2 mm/second is recommended.
 - Recommendation: While the Dispersion Wire is rotating, hold the MDU with one hand, while using the other hand to securely grasp the catheter proximal to the access site between two fingers and pullback ensuring the catheter does not kink or become damaged.
 - Orient the Catheter/Wire to maintain a straight position and to avoid kinking or creating an acute bend between the vascular access site and MDU.

Caution: A kink could cause damage to the device or patient injury.

Caution: Do not exert excessive force when withdrawing or advancing the catheter. If resistance is encountered determine if remedial action is necessary. Failure to do so may result in device damage or patient injury.

2. Adjust the Dispersion Wire rotation speed as desired.
3. Continue the infusion procedure.
4. After approximately one third of the total treatment is complete, check to determine that desired agent dispersion has been achieved. If adequate dispersion has not been achieved, it may be necessary to repeat the infusion and dispersion of the agent.
NOTE: Resheath the Dispersion Wire by moving the Guide Wing from Position 2 to Position 1 in the Mating Alignment Channel prior to advancing the Dispersion Wire Tip to the desired position and repeat Procedural Steps 1-3.
5. With approximately half of the vessel's targeted infusion length remaining, slide the access device to the most proximal end of the catheter assembly.
6. While the catheter is still within the vessel, use vascular imaging to verify that the desired outcome has been achieved.
7. Re-sheath the Dispersion Wire Tip by moving the Guide Wing to Position 1 before removing catheter from the patient. Disable the MDU:
 - a. Disengage the syringe from the Syringe Locking Support on the MDU. (Figure 2, 9)
 - b. Rotate the catheter assembly to unlock from Position 2. (Figure 4)
 - c. Move the Catheter Assembly Guide Wing's Cartridge to the mating alignment channel Position 1. (Figure 4)

NOTE: Moving the Guide Wing into mating alignment channel Position 1 will re-sheath the Dispersion Wire Tip and prevent the wire from rotating while removing device from patient.

NOTE: The Catheter Assembly **cannot** be separated from the MDU.

Post-Procedure:

1. Dispose of the products and packaging per institutional protocol.
2. Institute appropriate post-procedural patient care.

ELECTROMAGNETIC COMPATABILITY

Medical Electrical Equipment needs special precautions regarding EMC and needs to be installed and put into service according to the EMC information provided in the accompanying documents. Portable and Mobile RF communications equipment can effect medical electrical equipment.

WARNING The use of accessories, other than those specified, may result in increased emissions or decreased immunity of the equipment. The equipment should not be used adjacent to other equipment; and if adjacent to the equipment should be observed to verify normal operation in the configuration in which it will be used.

| Guidance and Manufacturer's Declaration - Emissions | | |
|---|-------------------|--|
| The ClariVein® IC is intended for use in the electromagnetic environment specified below. The user ensure that it is used in such an environment. | | |
| Emissions Test | Compliance | Electromagnetic Environment – Guidance |
| RF Emissions CISPR 11 | Group 1 | The ClariVein® IC uses RF energy only for its internal function. Therefore, its RF emissions are very low and are not likely to cause any interference in nearby electronic equipment. |
| RF Emissions CISPR 11 | Class B | |
| Harmonics IEC 61000-3-2 | N/A | |
| Flicker IEC 61000-3-3 | N/A | |
| | | The ClariVein® IC is suitable for use in all establishments, including domestic, and those directly connected to the public low-voltage power supply network that supplies buildings used for domestic purposes. |

| Guidance and Manufacturer's Declaration – Immunity | | | |
|--|---|--------------------------|--|
| The ClariVein® IC is intended for use in the electromagnetic environment specified below. The user should ensure that it is used in such an environment. | | | |
| Immunity Test | IEC 60601 Test Level | Compliance Level | Electromagnetic Environment – Guidance |
| ESD IEC 61000-4-2 | ±6kV Contact ±8kV Air | ±6kV Contact ±8kV Air | Floors should be wood, concrete or ceramic tile. If floors are synthetic, the r/h should be at least 30% |
| EFT IEC 61000-4-4 | ±2kV Mains ±1kV I/Os | N/A | Mains power quality should be that of a typical commercial or hospital environment. |
| Surge IEC 61000-4-5 | ±1kV Differential ±2kV Common | N/A | Mains power quality should be that of a typical commercial or hospital environment. |
| Voltage Dips/Dropout IEC 61000-4-11 | >95% Dip for 0.5 Cycle 60% Dip for 5 Cycles 30% Dip for 25 Cycles >95% Dip for 5 Seconds | N/A | Mains power quality should be that of a typical commercial or hospital environment. If the user of the ClariVein® IC requires continued operation during power mains interruptions, it is recommended that the ClariVein® IC be powered from an uninterruptible power supply or battery. |
| Power Frequency 50/60Hz Magnetic Field IEC 61000-4-8 | 3A/m | 3A/m | Power frequency magnetic fields should be that of a typical commercial or hospital |

| Guidance and Manufacturer’s Declaration – Immunity for ME Equipment/Systems that are NOT life supporting. | | | |
|--|-----------------------------|-------------------------|--|
| The ClariVein® IC is intended for use in the electromagnetic environment specified below. The user should ensure that it is used in such an environment. | | | |
| Immunity Test | IEC 60601 Test Level | Compliance Level | Electromagnetic Environment – Guidance |
| Radiated RF IEC 61000-4-3 | 3 V/m 80 MHz to 2.5 GHz | (E1)=3V/m | Portable and mobile communications equipment should be separated from the ClariVein® IC by no less than the distances calculated/listed below: D=(3.5/V1)(Sqrt P) 150 to 80 MHz D=(3.5/E1)(Sqrt P) 80 to 800 MHz D=(7/E1)(Sqrt P) 800 MHz to 2.5 GHz where P is the max power in watts and D is the recommended separation distance in meters. Field strengths from fixed transmitters, as determined by an electromagnetic site survey, should be less than the compliance levels (E1). Interference may occur in the vicinity of equipment containing a transmitter. |

| Recommended Separation Distances between portable and mobile RF Communications equipment and the ClariVein® IC which is not NOT Life-supporting. | | | |
|---|---|--|---|
| The ClariVein® IC is intended for use in the electromagnetic environment in which radiated disturbances are controlled. The user can help prevent electromagnetic interference by maintaining a minimum distance between portable and mobile RF Communications Equipment and the ClariVein® IC as recommended below, according to the maximum output power of the communications equipment. | | | |
| Max Output Power (Watts) | Separation (m) 150 to 80MHz D=(3.5/V1)(Sqrt P) | Separation (m) 180 to 800MHz D=(3.5/E1)(Sqrt P) | Separation (m) 800MHz to 2.5GHz D=(7/E1)(Sqrt P) |
| 0.01 | 0.116667 | 0.116667 | 0.233333 |
| 0.1 | 0.368932 | 0.368932 | 0.737865 |
| 1 | 1.166667 | 1.166667 | 2.333333 |
| 10 | 3.689324 | 3.689324 | 7.378648 |
| 100 | 11.66667 | 11.66667 | 23.33333 |

WARRANTY

Vascular Insights™, LLC (“Vascular Insights”) warrants that reasonable care has been used in the design and manufacture of this instrument and that it is free from manufacturing defects resulting from inferior workmanship or material that interferes with the ordinary use or functionality of the instrument for which it was sold by Vascular Insights™ or its authorized vendor. The warranty covers only manufacturing defects that are reported to Vascular Insights™ within one (1) year from the date that the instrument was delivered by Vascular Insights™ or its authorized vendor to the end user who purchased the instrument for his/her/its or his/her/its employees’ use. This warranty is the

ClariVein® is a registered trademark of Vascular Insights™, LLC in the United States.

sole and exclusive warranty and is in lieu of and excludes all other warranties not expressly set forth herein, whether express or implied, statutory or otherwise, including, but not limited to, any warranties of merchantability, fitness for a particular purpose, non-infringement, title or workmanship.

Vascular Insights™ sole and exclusive obligation under this warranty is limited to the repair or replacement of this instrument, as Vascular Insights™ may determine in its sole discretion.

Handling, storage, cleaning and sterilization of this instrument as well as other factors relating to the patient, diagnosis, treatment, surgical procedures, and other matters beyond Vascular Insights™ control directly affect the instrument and the results obtained from its use.















Vascular Insights™ neither assumes, nor authorizes any other person to assume for it, any other or additional liability or responsibility in connection with this instrument or warranty. Vascular Insights™ assumes no liability whatsoever with respect to (i) the instrument, if it is reused, reprocessed, resterilized, modified, repaired or altered in any way, (ii) accidental damage to, or wear and tear on any part of the instrument, (iii) defects or damages that result from improper use, storage, misuse, reuse or abuse, accident or neglect, and (iv) the instrument, if any serial number has been removed, altered or obliterated or if other evidence of tampering exists.

Vascular Insights™ and any affiliate shall in no event be liable to the customer or any other person for any direct, indirect, incidental, consequential, exemplary, special or punitive damages or losses or expenses directly or indirectly arising from or in any way connected with the instrument or its use, including, without limitation, lost business or lost profits, whether or not such liability has been foreseen or was foreseeable, even if Vascular Insights™ has been advised of the possibility thereof. if and to the extent that Vascular Insights™, notwithstanding the foregoing, is liable for damages under any applicable law of mandatory application, the total and aggregate liability of Vascular Insights™ shall not exceed the total price paid to Vascular Insights™ or its authorized vendor for its sale of the instrument to the customer. if and to the extent that any applicable law of mandatory application provides that, notwithstanding the foregoing, any disclaimer or exclusion or limitation of liability, or part thereof, set forth herein is not valid or enforceable, such disclaimer or exclusion or limitation of liability shall be interpreted and, as necessary, deemed reformed so that it is valid and enforceable and approximates the intent of the parties as reflected herein.

Solely if the instrument is sold or used outside of the United States of America, notwithstanding anything to the contrary stated herein, nothing in this warranty shall exclude or in any way limit Vascular Insights™ liability to the end user who purchased the instrument for his/her/its or his/her/its employees' use or any person claiming for or through such end user or any other person, for any liability to the extent such may not be excluded or limited as a matter of mandatory applicable law.

This warranty and its application shall be governed by the law of the State of Massachusetts, United States of America, without consideration of any conflict of laws or international private law rules that would result in the application of the law of any other jurisdiction. The application of the United Nations Convention for the International Sale of Goods, to the extent it is applicable, is hereby expressly disclaimed.

DEFINITIONS OF SYMBOLS

| | | | |
|--|------------------------------|---|-------------------------------|
|  | Prescription Use Only | | |
|  | Catalog number |  | Use by date |
|  | Batch code |  | Manufacturer |
|  | Contents |  | Sterilized utilizing EO |
|  | Consult instructions for use |  | Keep away from rain |
|  | BF, Applied part |  | Fragile, handle with care |
|  | Do not resterilize |  | Do not use if package damaged |
|  | Do not reuse | | |



 Manufacturer
Vascular Insights™, LLC
1 Pine Hill Drive, Two Batterymarch Park, Suite 100
Quincy, MA 02169
+1-203-446-5711
www.vascularinsights.com

US Patents 7,862,575, 7,967,834, 8,465,508, 8,696,645 and other United States and foreign patents pending.
© 2016 Vascular Insights™, LLC. All rights reserved.

IFU-001 Rev. B